









PORT TYPE	1	2	3	4
L				
T				



Standard Material Specifications

No.	Part Name	Materials
1	Body	SS316
2	Cap	SS316
3	Ball Seat	TFM-1600
4	Ball	SS316
5	Stem	SS316
6	Gasket	TFM-1600
7	Thrust Washer	TFM-1600
8	Packing	TFM-1600
9	Ring	SS304
10	Washer	SS410
11	Gland Washer	SS304
12	Locking Plate	SS304
13	Washer	SS304
14	End Cap	SS316
15	Handle Sleeve	SS304

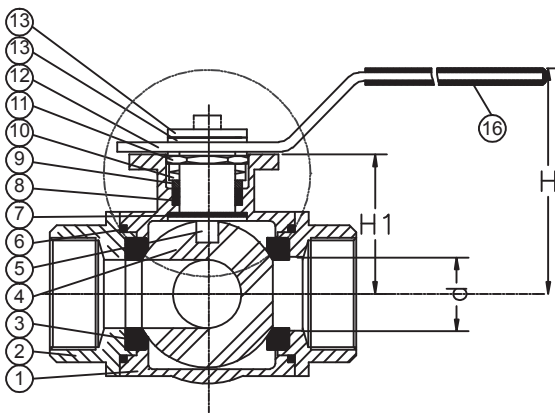
PRESSURE TEMPERATURE RATINGS

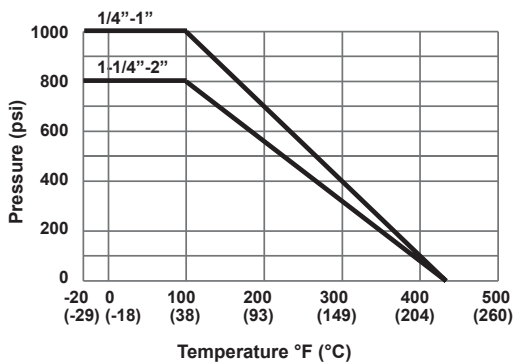

Dimensions (mm)

Size	d	L	H	D1	A	C	D	F	d1	d2	d3	d4	H1	torque kgf - cm
1/4"	11	69	36	106	13.5	12	9	35.1	6	6	36	42	42	40
3/8"	11	69	36	106	13.5	12	9	35.1	6	6	36	42	42	40
1/2"	12.7	75	36	106	13.5	12	9	38	6	6	36	42	42	45
3/4"	16	86	42	133	13.5	15	11	43.8	6	7.1	36	42	46.5	60
1"	20	101	42	133	12	15	11	50.3	6	7.1	42	50	55	60
1-1/4"	25	115	50	133	12	15	11	57.5	7.1	9.2	42	50	63	100
1-1/2"	32	125	50	187	15	15	11	64	7.1	9.2	50	70	74	140
2"	38.1	149	70	187	15	18.5	14	75.5	9.2	11.4	50	70	88.3	408

*last updated 03/16